

Hear the truth.



J33/J33i/J22/J22i

OWNER'S MANUAL

Thank you for choosing JBL. We're confident that the headphones you've chosen will provide every note of enjoyment that you expect – and that when you think about purchasing additional audio equipment for your home, car or office, you'll once again choose the JBL brand.

Nous vous remercions d'avoir choisi JBL. Nous sommes convaincus que le casque d'écoute que vous avez choisi vous apportera chaque note de plaisir que vous attendez – et que, lorsque vous songerez à acheter de l'équipement audio supplémentaire pour votre domicile, votre voiture ou votre bureau, une fois de plus, vous choisirez la marque JBL.

Gracias por elegir JBL. Estamos seguros de que los auriculares que ha elegido cumplirán con todas sus expectativas y de que cuando piense en comprar un equipo de audio adicional para su hogar, coche u oficina, volverá a elegir los productos JBL.

Obrigado por escolher a JBL. Estamos confiantes de que o fones de ouvido que você escolheu lhe dará a diversão que você espera, e que quando você pensar em comprar outros equipamentos de áudio para sua casa, carro ou escritório, você escolherá novamente os produtos da JBL.

Vielen Dank, dass Sie sich für JBL entschieden haben. Wir sind uns sicher, dass die von Ihnen erworbenen Kopfhörer all Ihre Ansprüche an vollkommenen Musikgenuss erfüllen und Sie dadurch beim nächsten Kauf von Audiogeräten für daheim, Ihr Auto oder Büro der Marke JBL wieder den Vorzug geben werden.

Grazie per aver scelto JBL. Siamo certi che le cuffie che avete scelto forniranno tutto il divertimento che vi aspettate - e che quando penserete di acquistare altra attrezzatura audio per la casa, auto o ufficio, sceglierete ancora una volta i prodotti JBL.

Hartelijk dank dat u voor JBL hebt gekozen. Wij vertrouwen erop dat de hoofdtelefoon die u hebt gekozen u alle plezier biedt dat u ervan verwacht en dat u bij de aanschaf van extra audioapparatuur voor thuis, in de auto of op kantoor opnieuw voor JBL-producten zult kiezen.

Takk for at du valgte JBL. Vi er sikre på at disse hodetelefonene vil gi deg all den musikalske nytelsen som du forventer, og at når du planlegger å kjøpe ekstra lydutstyr til hjemmet og bilen, kommer du nok en gang til å velge utstyr fra JBL.

JBL kiittää luottamuksestasi. Valitsemasi kuulokkeet takaavat varmasti nautinnollisia kokemuksia, ja kun on aika miettiä muiden äänilaitteiden hankkimista kotiin, autoon tai toimistoon, harkitse toivottavasti jälleen JBL-tuotteita.

Благодарим вас за выбор продукции JBL. Мы уверены, что выбранные вами наушники доставят ожидаемое наслаждение от каждой ноты, и когда вы решите приобрести дополнительное аудиооборудование для своего дома, автомобиля или офиса, вы опять выберете продукцию бренда JBL.

Tack för att du väljer JBL. Vi är övertygade om att du kommer att få precis lika stor glädje av de här hörlurarna som du förväntar dig – och hoppas att du väljer JBL även nästa gång du ska köpa ljudutrustning till hemmet, bilen eller kontoret.

Tak, fordi du valgte JBL. Vi er overbevist om, at de hovedtelefoner, du har valgt, vil opfylde alle dine forventninger – og at du, når du overvejer at anskaffe ekstra lydudstyr til hjemmet, bilen eller kontoret, endnu engang vil vælge JBL-produkter.

JBL の製品をお選びいただき、ありがとうございます。JBLは、お選びいただいたヘッドフォンがご期待に添った音質をお届けできると共に、お客様がご家庭や自動車、オフィスにオーディオ設備を追加することをご検討になるとき、再びJBLブランドをお選びいただけると信じております。

JBL을 선택해 주셔서 감사합니다. 선택하신 JBL 헤드폰은 사용자가 기대하는 모든 즐거움을 제공합니다. 가정이나 자동차, 사무실에 추가로 오디오 기기를 구매하려고 생각하신다면 다시 한 번 JBL 제품을 선택하실 것이라고 자신합니다.

感謝您選擇 JBL。我們相信，您選擇的耳機帶給您的每個音符，都將是您所期待的享受；且當您日後希望為住家、汽車或辦公室購買其他音訊設備時，仍會再次選擇 JBL 品牌。

感谢您选择 JBL。我们相信，您选择的耳机必将满足您对每一个音符的期待。当您考虑购买其他音频设备供家庭、汽车或办公室使用时，希望您还能再次选择 JBL 品牌。

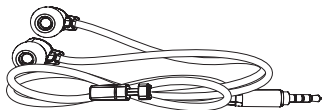

1x (J33)

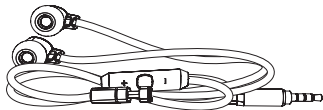

1x (J33i)

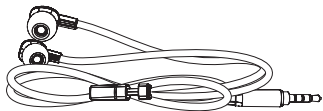

1x (J22)

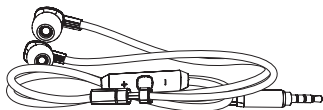

1x (J22i)

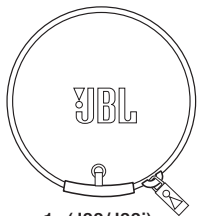

1x (J33/J33i)

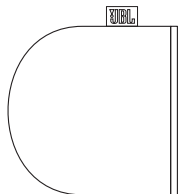

1x (J22/J22i)



1x



1x



1x (J33/J33i)

J33i/J22i:

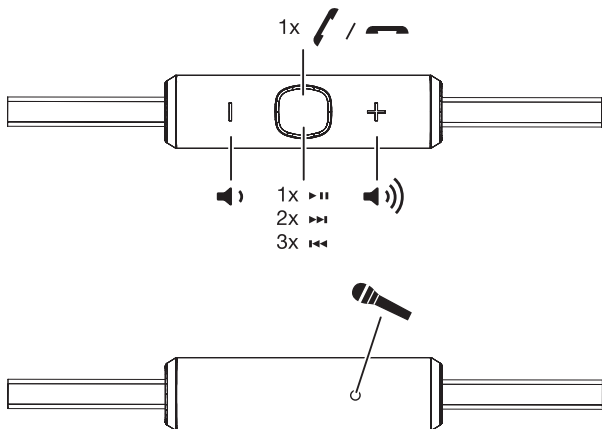

- The remote and mic are supported only by iPod nano (4th generation or later), iPod classic (120GB, 160GB), iPod touch (2nd generation or later), iPhone 3GS or later, and iPad. The remote is supported by iPod shuffle (3rd generation or later). Audio is supported by all iPod models and iPad.
- La télécommande et le micro ne sont pris en charge que par iPod nano (4e génération et suivantes), iPod classic (120 ou 160 Go), iPod touch (2e génération et suivantes), iPhone 3GS (et modèles plus récents) et iPad. La télécommande est prise en charge par iPod shuffle (3e génération et suivantes). L'audio est pris en charge par tous les modèles iPod et iPad.

- El control remoto y el micrófono solo son compatibles con iPod nano (4th generation o posteriores), iPod classic (120 GB, 160 GB), iPod touch (2nd generation y posteriores), iPhone 3GS o posterior y iPad. El control remoto es compatible con iPod shuffle (3rd generation o posteriores). El audio es compatible con todos los modelos de iPod y iPad.
- O controle remoto e o microfone são compatíveis apenas com iPod nano (4ª geração e posteriores), iPod classic (120 GB, 160 GB), iPod touch (2ª geração e posteriores), iPhone 3GS e posteriores e iPad. O controle remoto é compatível com iPod shuffle (3ª geração e posteriores). O áudio é compatível com todos os modelos de iPod e iPad.
- Die Fernbedienung und das Mikrofon werden nur unterstützt von: iPod nano (4G und später), iPod classic (120 GB, 160 GB), iPod touch (2G und später), iPhone 3GS und später sowie iPad. Die Fernbedienung wird unterstützt von: iPod shuffle (3G und später). Audio wird von allen iPod-Modellen und vom iPad unterstützt.
- Il telecomando e il microfono sono supportati solo da iPod nano (4° generazione e successive), iPod classic (120 GB, 160 GB), iPod touch (2° generazione e successive), iPhone 3GS o successive e iPad. Il telecomando è supportato da iPod shuffle (3° generazione e successive). L'audio è supportato da tutti i modelli di iPod e iPad.
- De afstandsbediening en microfoon worden uitsluitend ondersteund door de iPod nano (4th generation of later), iPod classic (120 GB, 160 GB), iPod touch (2nd generation of later), iPhone 3GS of later en iPad. De afstandsbediening wordt ondersteund door de iPod shuffle (3rd generation of later). Audio wordt ondersteund door alle iPod-modellen en de iPad.
- Fjernkontrollen og mikrofonen støttes kun av iPod nano (fjerde generasjon eller senere), iPod classic (120GB, 160GB), iPod touch (andre generasjon eller senere), iPhone 3GS eller nyere, og iPad. Fjernkontrollen støttes av iPod shuffle (tredje generasjon eller senere). Lyd støttes av alle iPod-modeller og iPad.
- Kauko-ohjain ja mikrofonit toimivat ainoastaan iPod nanon (4. sukupolvi tai uudempi), iPod classicin (120 Gt, 160 Gt), iPod touchin (2. sukupolvi), iPhone 3GS:n tai uudemman mallin sekä iPadin kanssa. iPod shuffle (3. sukupolvi tai uudempi) tukee kauko-ohjainta. Kaikki iPod-mallit ja iPad tukevat äänen toistoa.

- ПДУ и микрофон поддерживаются только устройствами iPod nano (4-го поколения и следующие модели), iPod classic (120 ГБ и 160 ГБ), iPod touch (2-го поколения и следующие модели), iPhone 3GS и следующие модели, а также iPad. iPod shuffle (3-го поколения и следующие модели) поддерживает ПДУ. Аудио поддерживается всеми моделями iPod и iPad.
- Fjärrkontrollen och mikrofonen fungerar endast tillsammans med iPod nano (4:e generationen eller senare), iPod classic (120 GB, 160 GB), iPod touch (2:a generationen eller senare), iPhone 3GS eller senare, samt med iPad. Fjärrkontrollen fungerar tillsammans med iPod shuffle (3:e generationen eller senare). Ljudet fungerar tillsammans med alla modeller av iPod och iPad.
- Fjernbetjeningen og mikrofonen understøttes kun af iPod nano (4. generation eller nyere), iPod classic (120 GB, 160 GB), iPod touch (2. generation eller nyere), iPhone 3GS eller nyere og iPad. Fjernbetjeningen understøttes af iPod shuffle (3. generation eller nyere). Lyd understøttes af alle iPod-modeller og iPad.
- リモコンとマイクは、iPod nano（第4世代以降）、iPod classic（120GB、160GB）、iPod touch（第2世代以降）、iPhone 3GS以降、iPadでのみサポートされています。リモコンは、iPod shuffle（第3世代以降）でサポートされています。オーディオはすべてのiPodモデルおよびiPadでサポートされています。
- 리모컨과 마이크는 iPod nano (4세대) 이상, iPod classic(120GB, 160GB), iPod touch (2세대) 이상, iPhone 3GS 이상 및 iPad에서만 지원됩니다. 리모컨은 iPod shuffle (3세대) 이상에서 지원됩니다. 오디오는 모든 iPod 모델 및 iPad에서 지원됩니다.
- 僅有 iPod nano（第4代或更新機種）、iPod classic（120GB、160GB）、iPod touch（第2代或更新機種）、iPhone 3GS 或更新機種、以及 iPad 支援遙控器與麥克風。iPod shuffle（第3代或更新機種）支援遙控器。所有 iPod 機種與 iPad 都支援音訊。
- 只有 iPod nano（第四代及第四代以上）、iPod classic（120GB、160GB）、iPod touch（第二代及第二代以上）、iPhone 3GS 及更新产品、以及 iPad 支持遙控功能和麥克風。iPod shuffle（第三代及第三代以上）支持遙控功能。所有 iPod 型号及 iPad 均支持音頻。

J33/J33i:

1.

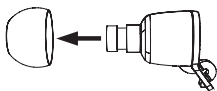

www.complyfoam.com

2.

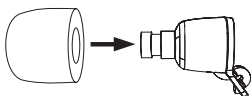

3.

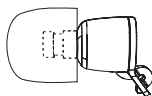

4.

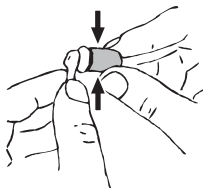

www.complyfoam.com

5.

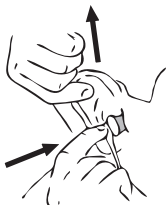

6.



J22/J22i

Frequency range:	18Hz – 20kHz
Driver size:	8.6mm
Cable:	1.3m (4.3 ft) flat
Plug:	3.5mm (1/8") gold-plated

Plage de fréquences :	18 Hz à 20 kHz
Taille du diffuseur :	8,6 mm
Câble :	1,3 m (4,3 pi) uniforme
Connecteur :	3,5 mm (1/8 po) plaqué or

Rango de frecuencia:	18 Hz – 20 kHz
Tamaño del controlador:	8,6 mm
Cable:	1,3 m; plano
Conector:	3,5 mm; dorado

Faixa de frequência:	18 Hz – 20 kHz
Tamanho da unidade:	8,6 mm
Cabo:	1,3 m (4,3 ft) liso
Plugue:	3,5 mm (1/8") folheado a ouro

Frequenzbereich:	18 Hz – 20 kHz
Membrangröße:	8,6 mm
Kabel:	1,30 m, Flachkabel
Stecker:	3,5 mm, vergoldet

Gamma di frequenza:	18 Hz – 20 kHz
Dimensioni unità:	8,6 mm
Cavo:	1,3 m piatto
Connettore:	3,5 mm (1/8") placcato in oro

Frekventiebereich:	18 Hz – 20 kHz
Groote driver:	8,6 mm
Kabel:	1,3 m plat
Stekker:	3,5 mm (1/8"), verguld

Frekvensområde:	18 Hz – 205 kHz
Driver-størrelse:	8,6 mm
Ledning:	1,3 m flat
Støpsel:	3,5 mm gullbelagt

Taajuusalue:	18 Hz – 20 kHz
Elementin koko:	8,6 mm
Kaapeli:	1,3 m, suora
Pistoke:	3,5 mm, kullattu

J22/J22i

Частотный диапазон:	18 Гц – 20 кГц
Размер излучателя:	8,6 мм
Кабель:	1,3 м (4,3 фута), плоский
Разъем:	Позолоченный разъем 3,5 мм (1/8 дюйма)

Frekvensområde:	18 Hz – 20 kHz
Elementstorlek:	8,6 mm
Kabel:	1,3 m flatkabel
Kontakt:	3,5 mm guldpläterad

Frekvensområde:	18 Hz – 20 kHz
Driverstørrelse:	8,6 mm
Ledning:	1,3 m flad
Stik:	3,5 mm (1/8") guldplatteret

周波数範囲:	18Hz~20kHz
ドライバサイズ:	8.6mm
ケーブル長さ:	1.3m (4.3ft) フラット
プラグ:	3.5mm (1/8") 金メッキ

주파수 범위:	18Hz – 20kHz
드라이버 크기:	8.6mm
케이블:	1.3m(4.3피트), 평판
플러그:	3.5mm(1/8"), 도금

頻率範圍:	18Hz – 20kHz
驅動單元大小:	8.6公釐
電纜:	1.3公尺 (4.3英尺) 扁線
插頭:	3.5公釐 (1/8") 鍍金

頻率范围:	18Hz – 20kHz
驱动单元尺寸:	8.6mm
线缆长度:	1.3m (4.3 ft) 扁线
插头:	3.5mm (1/8") 镀金插头

J33/J33i

Frequency range:	10Hz – 24kHz
Driver size:	9.2mm
Cable:	1.3m (4.3 ft) flat
Plug:	3.5mm (1/8") gold-plated

Plage de fréquences :	10 Hz à 24 kHz
Taille du diffuseur :	9,2 mm
Câble :	1,3 m (4,3 pi) uniforme
Connecteur :	3,5 mm (1/8 po) plaqué or

Rango de frecuencia:	10 Hz – 24 kHz
Tamaño del controlador:	9,2 mm
Cable:	1,3 m; plano
Conector:	3,5 mm; dorado

Faixa de frequência:	10 Hz – 24 kHz
Tamanho da unidade:	9,2 mm
Cabo:	1,3 m (4,3 ft) liso
Plugue:	3,5 mm (1/8") folheado a ouro

Frequenzbereich:	10 Hz – 24 kHz
Membrangröße:	9,2 mm
Kabel:	1,30 m, Flachkabel
Stecker:	3,5 mm, vergoldet

Gamma di frequenza:	10 Hz – 24 kHz
Dimensioni unità:	9,2 mm
Cavo:	1,3 m piatto
Connettore:	3,5 mm (1/8") placcato in oro

Frequentiebereg:	10 Hz – 24 kHz
Groote driver:	9,2 mm
Kabel:	1,3 m plat
Stekker:	3,5 mm (1/8"), verguld

Frekvensområde:	10 Hz – 24 kHz
Driver-størrelse:	9,2 mm
Ledning:	1,3 m flat
Støpsel:	3,5 mm gullbelagt

Taajuusalue:	10 Hz – 24 kHz
Elementin koko:	9,2 mm
Kaapeli:	1,3 m, suora
Pistoke:	3,5 mm, kullattu

J33/J33i

Частотный диапазон:	10 Гц – 24 кГц
Размер излучателя:	9,2 мм
Кабель:	1,3 м (4,3 фута), плоский
Разъем:	Позолоченный разъем 3,5 мм (1/8 дюйма)

Frekvensområde:	10 Hz – 24 kHz
Elementstorlek:	9,2 mm
Kabel:	1,3 m flatkabel
Kontakt:	3,5 mm guldpåterad

Frekvensområde:	10 Hz – 24 kHz
Driverstørrelse:	9,2 mm
Ledning:	1,3 m flad
Stik:	3,5 mm (1/8") guldpletteret

周波数範囲:	10Hz~24kHz
ドライバーサイズ:	9.2mm
ケーブル長さ:	1.3m (4.3ft) フラット
プラグ:	3.5mm (1/8") 金メッキ

주파수 범위:	10Hz – 24kHz
드라이버 크기:	9.2mm
케이블:	1.3m(4.3피트), 평판
플러그:	3.5mm(1/8"), 도금

頻率範圍:	10Hz – 24kHz
驅動單元大小:	9.2公釐
電纜:	1.3公尺 (4.3英尺) 扁線
插頭:	3.5 公釐 (1/8") 鍍金

頻率范围:	10Hz – 24kHz
驱动单元尺寸:	9.2mm
线缆长度:	1.3m (4.3 ft) 扁线
插头:	3.5mm (1/8") 镀金插头



HARMAN

HARMAN International Industries, Incorporated
8500 Balboa Boulevard, Northridge, CA 91329 USA
516.255.4545 (USA only)

© 2012 HARMAN International Industries, Incorporated. All rights reserved.

JBL is a trademark of HARMAN International Industries, Incorporated, registered in the United States and/or other countries.

Comply is a trademark of Hearing Components, Inc.

iPhone, iPod and iPad are trademarks of Apple Inc., registered in the U.S. and other countries. iPod, iPhone and iPad not included. "Made for iPod", "Made for iPhone" and "Made for iPad" mean that an electronic accessory has been designed to connect specifically to iPod or iPhone or iPad, respectively, and has been certified by the developer to meet Apple performance standards. Apple is not responsible for the operation of this device or its compliance with safety and regulatory standards. Features, specifications and appearance are subject to change without notice.

Part No. JBLP4823 Rev: A

www.jbl.com